



12.4 GHz    N    N/O    S.P.3 T. SWITCH

OPTIONS : INDICATOR

**R F CHARACTERISTICS**

NUMBER OF WAYS : 3  
 FREQUENCY RANGE : 0 - 12.4 GHz  
 IMPEDANCE : 50 Ohms

FREQUENCY (GHz)	0 - 3	3 - 8	8 - 12.4
V.S.W.R <=	1.20	1.35	1.50
INSERT. LOSS <=	0.20 dB	0.35 dB	0.50 dB
ISOLATION >=	80 dB	70 dB	60 dB
AVER. POWER (*)	400 W	250 W	200 W

**ELECTRICAL CHARACTERISTICS**

ACTUATOR : NORMALLY OPEN  
 NOMINAL CURRENT AT 25° C (±10%) : 250 mA  
 ACTUATOR VOLTAGE (Vcc) : 12V (10.2 to 13V) / NEGATIVE COMMON  
 TERMINALS : solder pins (250°C max./30 sec.)  
 INDICATOR RATING : 1 W / 30 V / 100 mA

**MECHANICAL CHARACTERISTICS**

CONNECTORS : N female per MIL C 39012  
 LIFE : 2.000.000 cycles per position  
 SWITCHING TIME (nominal voltage;25° C) : < 15 ms  
 CONSTRUCTION : splashproof  
 WEIGHT : < 460 g

**ENVIRONMENTAL CHARACTERISTICS**

OPERATING TEMPERATURE RANGE (°C) : -40 , +85  
 STORAGE TEMPERATURE RANGE (°C) : -55 , +85

(\* : average power at 25° C per RF path)

This information is given as an indication. In the continual goal to improve our products, we reserve the right to make any modifications judged necessary

4112-9212

4113-9212 This information is given as an indication. In the continual goal to improve our products, we reserve the right to make any modifications judged necessary

**DRAWING**

General tolerance: ± 0,5 mm

**R573.112.300**

Page  
2/2

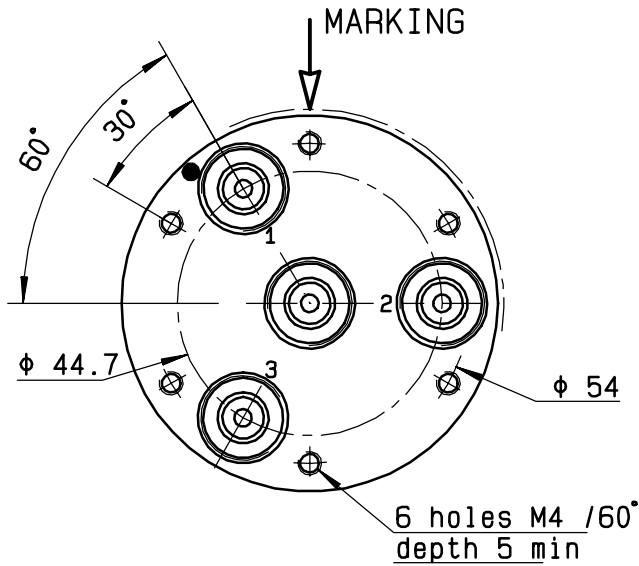

Voltage	RF continuity	Ind.
-C +1	IN ↔ 1	D.E
-C +2	IN ↔ 2	D.F
-C +3	IN ↔ 3	D.G

**TERMINALS**

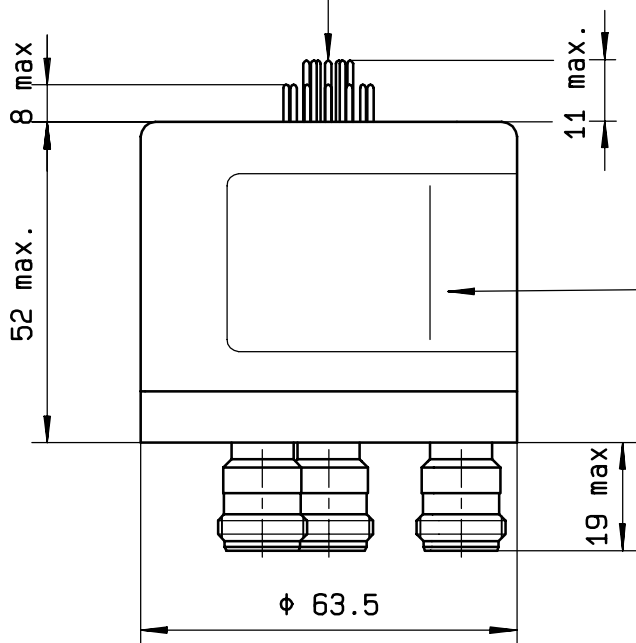

**TOP VIEW (TERMINALS)**

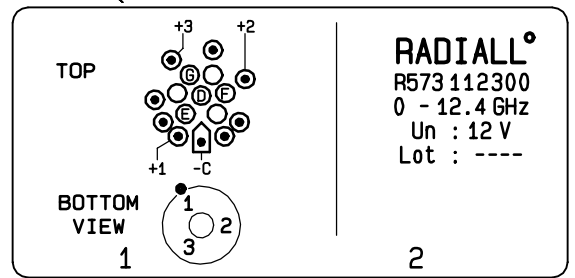

**SCHEMATIC DIAGRAM**

